

JBC

www.jbctools.com

INSTRUCTION MANUAL



Nano Soldering Station

Ref. NANE-C

Packing List

The following items should be included:

Control Unit 1 unit
 Ref. NAE-1C (120V)
 NAE-2C (230V)
 NAE-9C (100V)



Nano Handle 2 units
 Ref. NT115-A



Tool Holder 2 units
 Ref. 0016606



Cartridge dispenser Case 2 units
 Ref. 0020952
 0020953



Ref. 0020952:
 Ref. C115-101 x1
 C115-103 x1
 C115-107 x1
 C115-112 x1

Ref. 0020953:
 Ref. C115-105 x2
 C115-113 x2

Allen key 1 unit
 Ref. 009848



Metal Brush 1 unit
 Ref. CL2466



Brass Wool 1 unit
 Ref. CL6210



Power Cord 1 unit
 Ref. 0009417 (100/120V)
 0009401 (230V)



Manual 1 unit
 Ref. 0021449

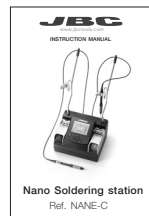

Features

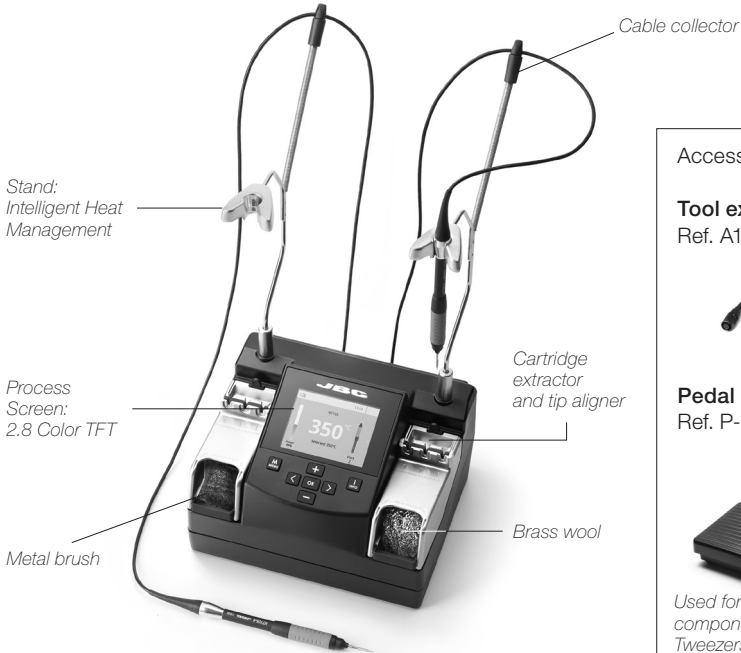

Accessories not included:

Tool extension cord (1m)
Ref. A1205



Pedal
Ref. P-005



Used for soldering chip components with Nano Tweezers (See page No. 8)

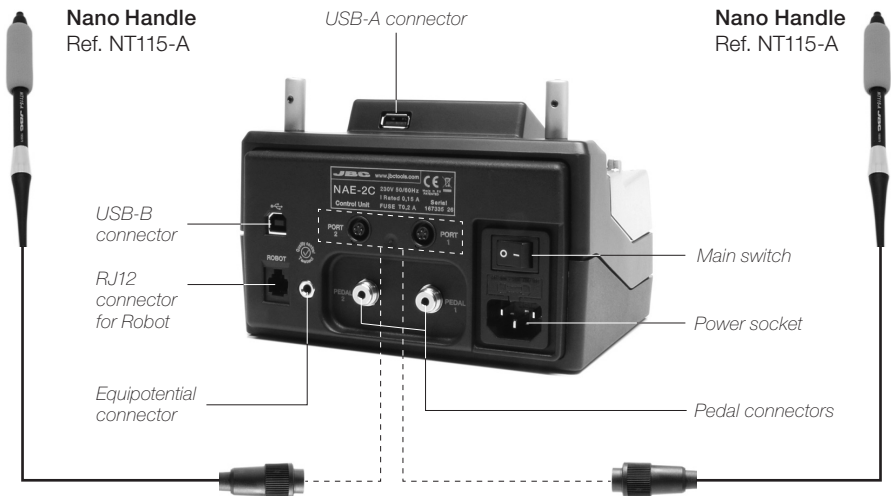

Tool Holder assembly

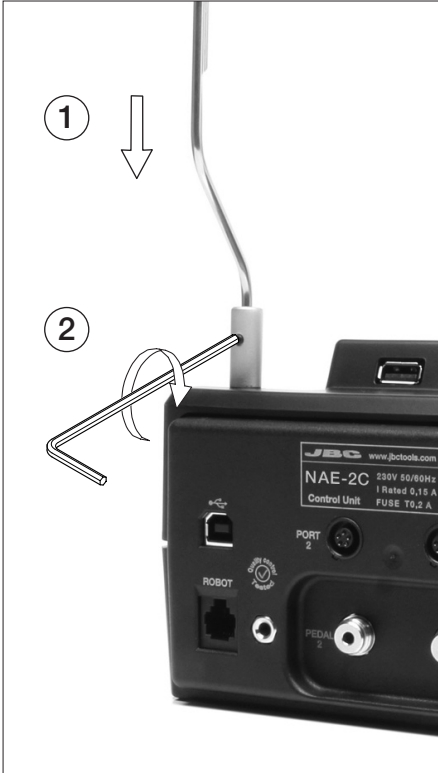

Cable assembly

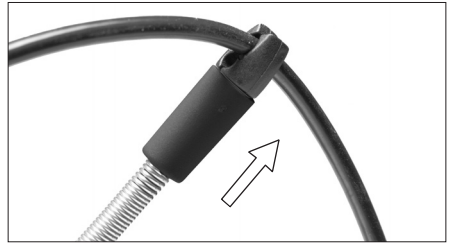
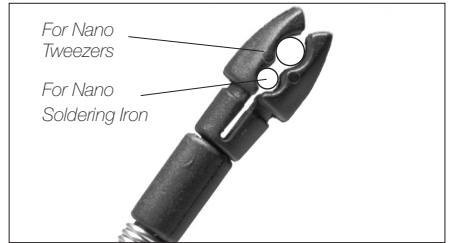

Changing the tip cleaning system

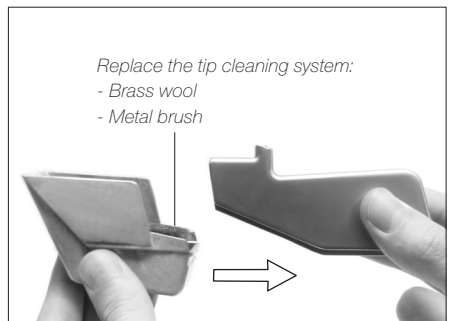
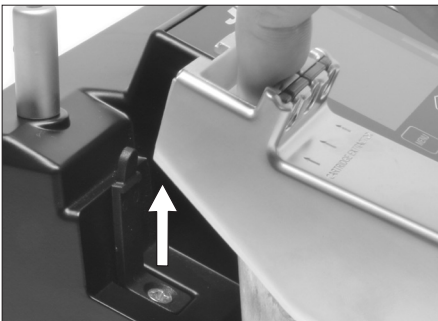

Changing grips

1. Push the grip with the tabs onto the handle.

Grip for NT115-A

Nano handle

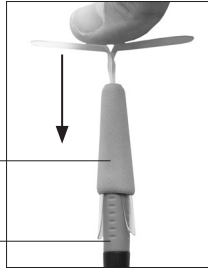

2. To remove the tabs, hold the grip and pull them out. Use a pliers if necessary.

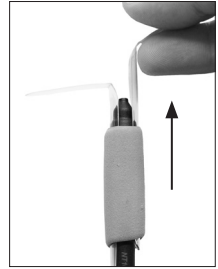

Changing cartridges

Save time and change cartridges safely without having to switch the station off.

Removing

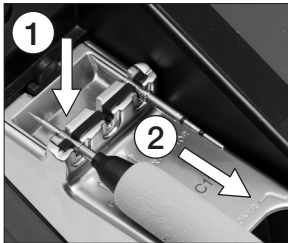

Place the cartridge in the slot as shown and pull the handle to remove it.

Inserting

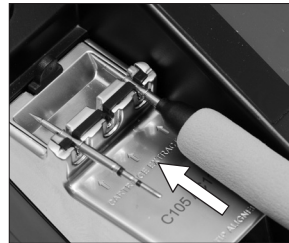

Push the cartridge into the handle to the mark*.

Aligning



Use the holes to rotate the cartridges for a proper alignment.

*Important

It is essential to insert the cartridges as far as the mark for a proper connection.

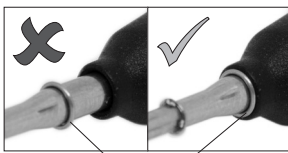

Mark

Compatible cartridges

The **NT115-A** works with **C115** cartridges. Find the model that best suits your soldering needs on www.jbctools.com



Round



Chisel



Bevel



Round bent



Knife



Stainless steel chisel

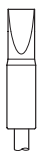

High thermal performance

Operation

The JBC Exclusive Heating System

Our revolutionary technology is able to recover tip temperature extremely quickly. It means the user can work at a lower temperature and improve the quality of soldering. The tip temperature is further reduced thanks to the Sleep and Hibernation modes which increase the tip life by 5.

1. Work

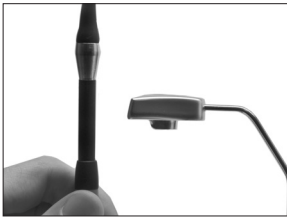

When the tool is lifted from the holder the tip will heat up to the selected temperature.

2. Sleep

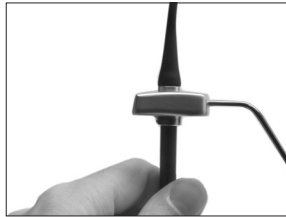

When the tool is in the holder, the temperature falls to the preset Sleep temperature.

3. Hibernation



After longer periods of inactivity, the power is cut off and the tool cools down to room temperature.

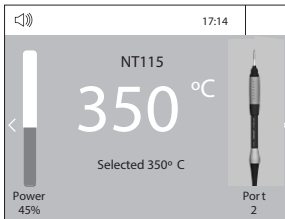

Tools Menu:

- Set temperature limits
- Set temperature levels

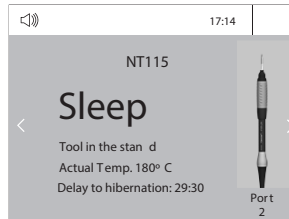

Tools Menu:

- Set Sleep temperature
- Set Sleep delay (from 0 to 9 min or no Sleep)



Tools Menu:

- Set Hibernation delay (from 0 to 60 min or no Hibernation)

Work Screen

The NANE-C offers an **intuitive user interface** which provides **quick access** to station parameters.

Original PIN: 0105

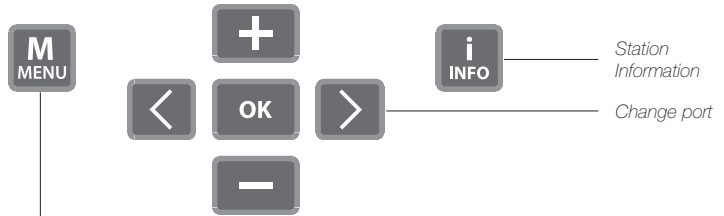
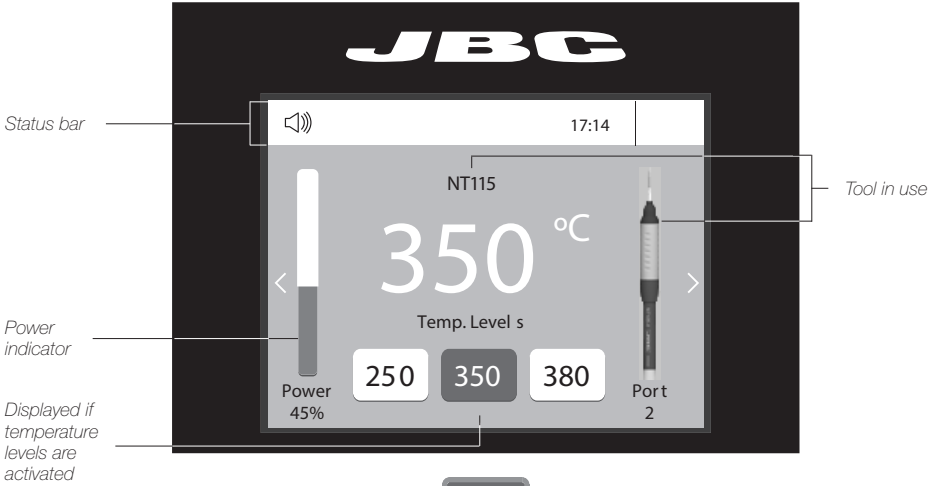

Menu Options

Press INFO for each parameter description.



Station



Tools



Counters



Peripherals



Graphics



Reset

System notifications (Status Bar)

- USB flash drive is connected.
- Station is controlled by a PC.
- Station is controlled by a robot.
- Station software update. Press INFO to start the process.
- Warning. Press INFO for failure description.
- Error. Press INFO for failure description, the type of error and how to proceed.

Soldering Chip components using Tweezers and pedal

1

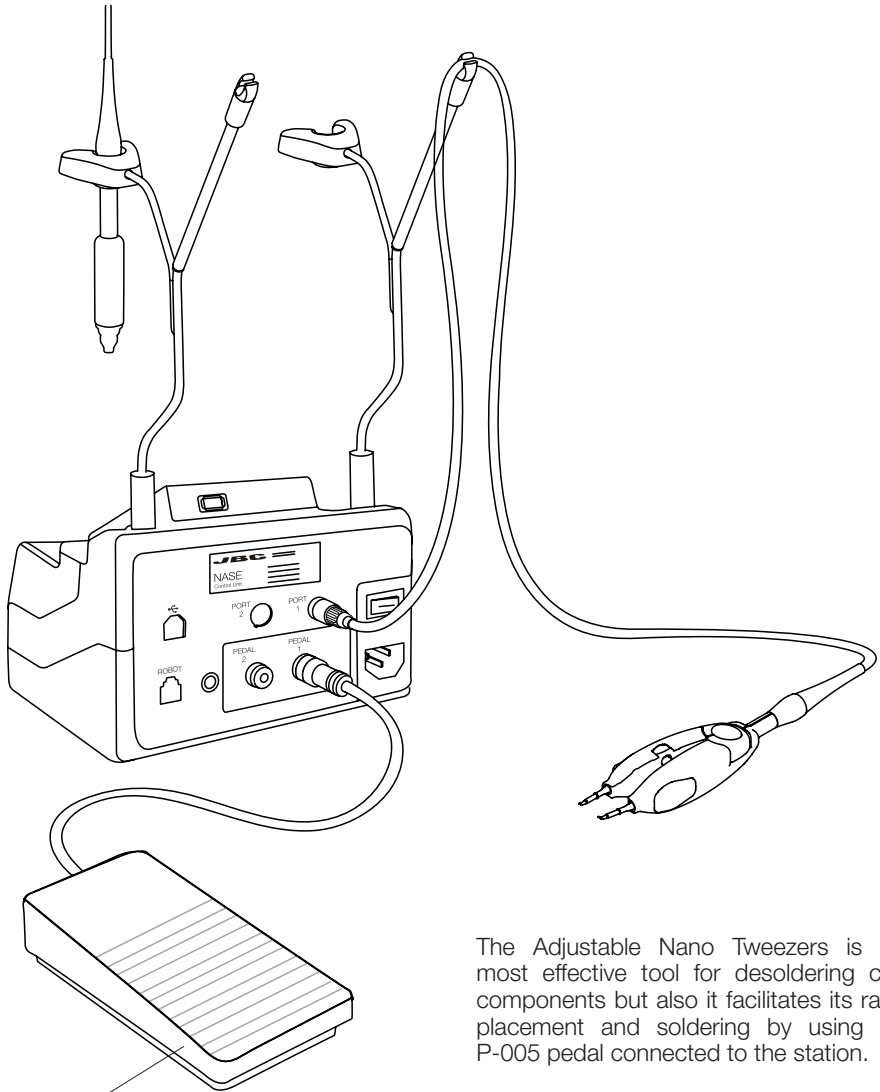

Pedal
Ref. P-005

The Adjustable Nano Tweezers is the most effective tool for desoldering chip components but also it facilitates its rapid placement and soldering by using the P-005 pedal connected to the station.

2

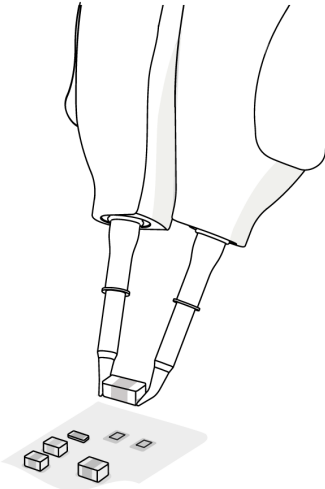

Use the tool to position the component on the previously tinned pads.



3

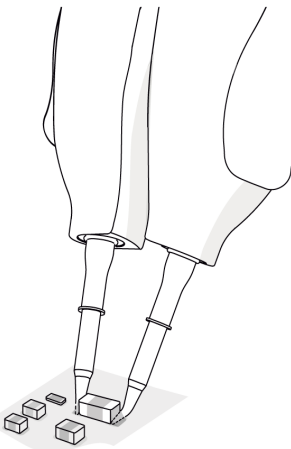

Once in position, press and hold the pedal to perform the soldering

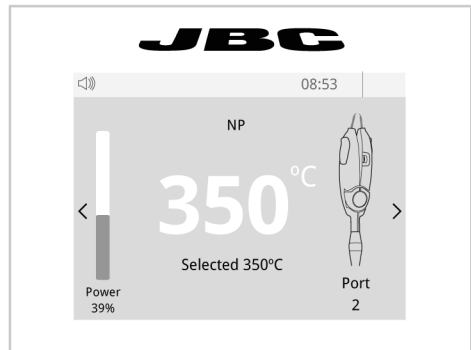

Process analysis



Graphics

By pressing **Graphics** in the main MENU, temperature and power figures in real time are displayed for each port. This helps you decide which tip to use to obtain the best quality solder joints.

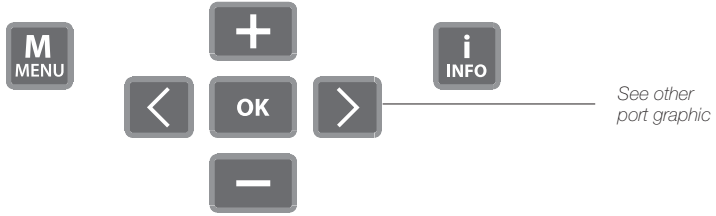
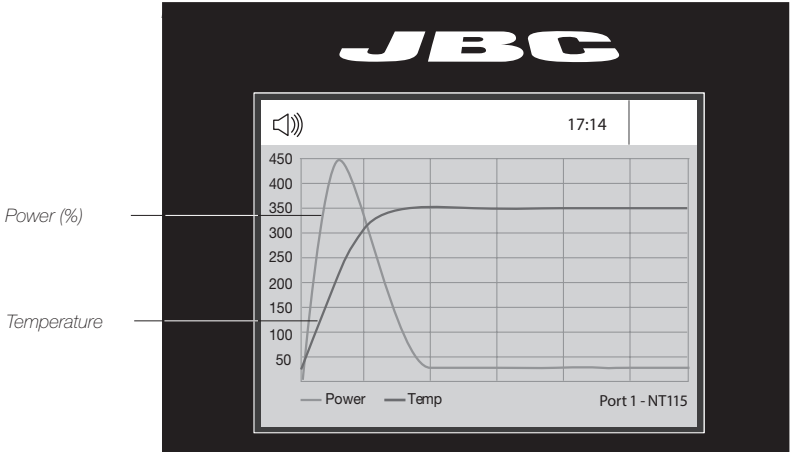

Export graphics

Insert a USB flash drive into the USB-A port to save your soldering process in csv format.



Soldering Net

Remotely manage and monitor as many stations as your PC can handle.

1. Download the **JBC Manager software** and the user manual from www.jbctools.com/manager.html
2. Connect the stations via USB-B connector and the PC will automatically detect them.
3. The notification  will be displayed on the station.

Functions:

- Set all the station parameters from your PC.
- Organize groups of stations and set all their parameters at the same time.
- Store specific configurations for later uses.
- Analyze the soldering graphics of the stations on your PC and export them.

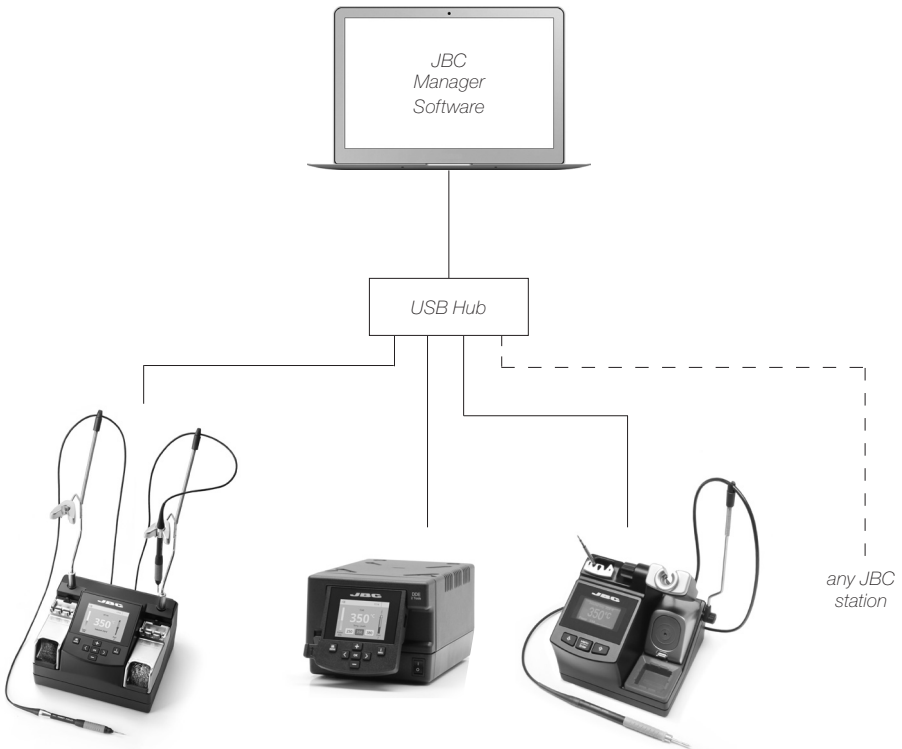

Working with Robots

Manage and monitor the station using a Robotic system.

1. Connect the tool to the station port.
2. Connect your Robot system to the Robot connector (RJ12) of the station.
DB9-RJ12 Adapter available only if necessary (Ref: 0013772).
3. Enable the Robot option in the station settings and the notification will be displayed: 
4. Set your Robot's commands according to the Robot Communication Protocol, available on the website www.jbctools.com/jbcsoftware-menu-115.html.

Robot

Control Unit

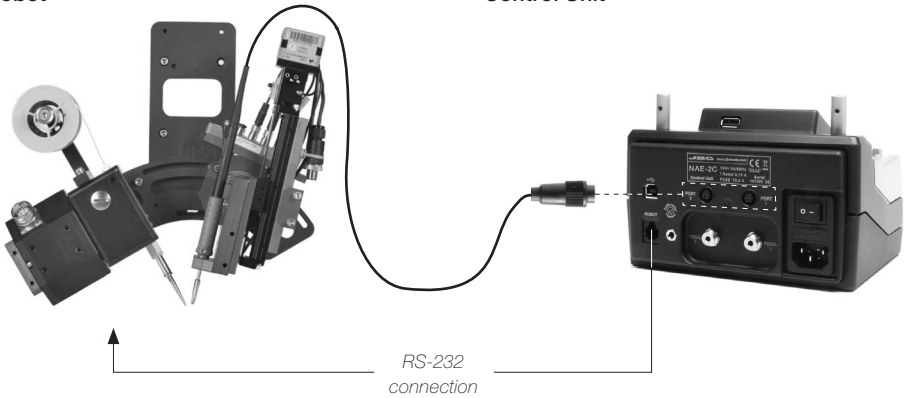

Update the station software

1. Download the JBC Update File from www.jbctools.com/software.html and save it on a USB flash drive. Preferably one with no other files.

2. Insert the USB flash drive to the station. The icon  is displayed while updating.



Maintenance

Before carrying out maintenance or storage, always allow the equipment to cool.

- Clean the station screen with a glass cleaner or a damp cloth.
- Use a damp cloth to clean the casing and the tool. Alcohol can only be used to clean the metal parts.
- Periodically check that the metal parts of the tool and stand are clean so that the station can detect the tool status.
- Maintain tip surface clean and tinned prior to storage in order to avoid tip oxidation. Rusty and dirty surfaces reduce heat transfer to the solder joint.
- Periodically check all cables and tubes.



- Replace a blown fuse as follows:

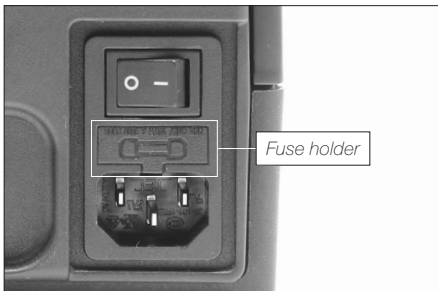

1. Pull off the fuse holder and remove the fuse. If necessary use a tool to lever it off.

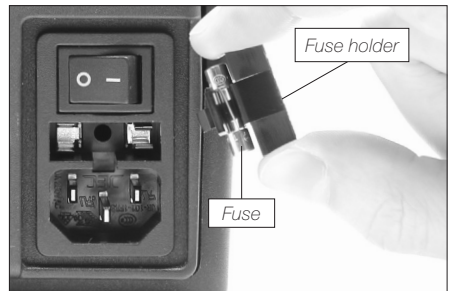

2. Press the new fuse into the fuse holder and replace it in the station.

- Replace any defective or damaged pieces. Use original JBC spare parts only.
- Repairs should only be performed by a JBC authorized technical service.

Safety



It is imperative to follow safety guidelines to prevent electric shock, injury, fire or explosion.

- Do not use the units for any purpose other than soldering or rework. Incorrect use may cause fire.
- The power cord must be plugged into approved bases. Be sure that it is properly grounded before use. When unplugging it, hold the plug, not the wire.
- Do not work on electrically live parts.
- The tool should be placed in the stand when not in use in order to activate the sleep mode. The soldering tip, the metal part of the tool and the stand may still be hot even when the station is turned off. Handle with care.
- Do not leave the appliance unattended when it is on.
- Do not cover the ventilation grills. Heat can cause inflammable products to ignite.
- Avoid the contact of flux with skin or eyes to prevent irritation.
- Be careful with the fumes produced when soldering.
- Keep your workplace clean and tidy. Wear appropriate protective glasses and gloves when working to avoid personal harm.
- Utmost care must be taken with liquid tin waste which can cause burns.
- This appliance can be used by children over the age of eight and also persons with reduced physical, sensory or mental capabilities or lack of experience provided that they have been given adequate supervision or instruction concerning use of the appliance and understand the hazards involved. Children must not play with the appliance.
- Maintenance must not be carried out by children unless supervised.

有害物质含量表

产品中有害物质的名称及含量

部件名称	有害物质					
	铅(Pb)	汞(Hg)	镉(Cd)	六价铬 (Cr(VI))	多溴联苯 (PBB)	多溴二苯醚 (PBDE)
烙铁头	○	○	○	○	○	○
手柄	○	○	○	○	○	○
电源线	○	○	○	○	○	○
主机	○	○	○	○	○	○
电源插座	○	○	○	○	○	○
保险丝	○	○	○	○	○	○
主开关	○	○	○	○	○	○
电位连接	X	○	○	○	○	○
变压器	○	○	○	○	○	○
线路板	X	○	○	○	○	○

○ 表示该有害物质在该部件所有均质材料中的含量均在GB/T 26572 规定的限量要求以下。
 X 表示该有害物质至少在该部件的某一均质材料中的含量超出GB/T 26572 规定的限量要求。

Exploded View

NANE-1C 120V
NANE-2C 230V
NANE-9C 100V
NANO REWORK STATION

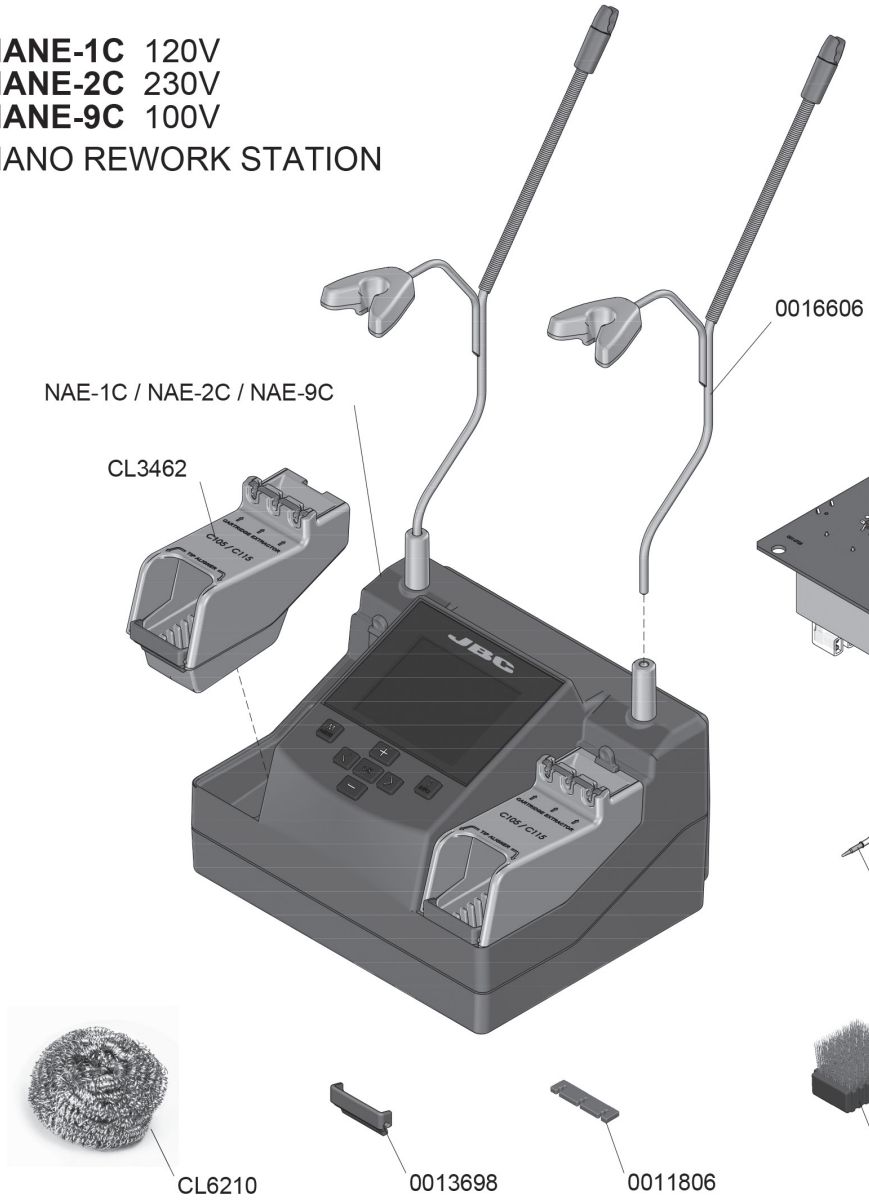

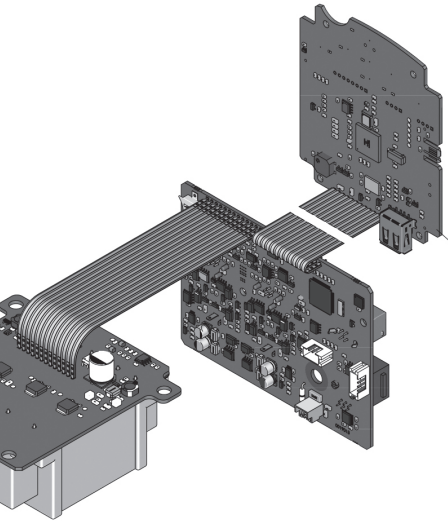

SPARE PARTS	
NAE-1C / NAE-2C / NAE-9C	
-CIRCUITS:	
NAE-1C	0020542
NAE-2C	0020541
NAE-9C	0020543
-ENCLOSURE	0016236

NANE-1C 120V FUSE T-0.5A
NANE-2C 230V FUSE T-0.2A
NANE-9C 100V FUSE T-0.5A

0020542 (120V)
 0020541 (230V)
 0020543 (100V)

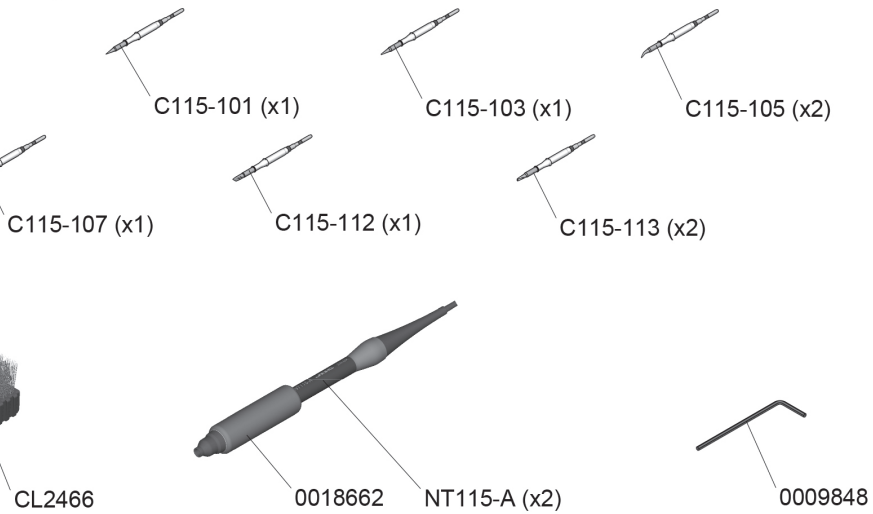

Specifications

NANE-1C 120V 50/60Hz. Input fuse: 0.5A. Output: 8.5V

NANE-2C 230V 50/60Hz. Input fuse: 0.2A. Output: 8.5V

NANE-9C 100V 50/60Hz. Input fuse: 0.5A. Output: 8.5V

- Net Weight: 2,5 kg (5.40 lb)
- Dimensions: 170 x 90 x 135 mm (6.70 x 3.54 x 5.31 in)
- Output Peak Power: 14W per tool
- Temperature Range: 90 - 450 °C (190 - 840 °F) ±5%
- Idle Temp. Stability (still air): ±3 °C (±5.5 °F)
- Tip to ground voltage: <2 mV
- Tip to ground resistance: <2 ohms
- Ambient operating temp: 10 - 40 °C (50 - 104 °F)
- USB-A / USB-B / Pedal connectors
- RJ12 connector for Robot

Complies with CE standards
ESD Safe

JBC

Warranty

JBC's 2 year warranty covers this equipment against all manufacturing defects, including the replacement of defective parts and labour. Warranty does not cover product wear or misuse. In order for the warranty to be valid, equipment must be returned, postage paid, to the dealer where it was purchased. **Please register your product warranty within 30 days of purchase in www.jbctools.com/productregistration.**



This product should not be thrown in the garbage.

In accordance with the European directive 2012/19/EU, electronic equipment at the end of their life must be collected and returned to an authorized recycling facility.



Manual in other languages available on our website

www.jbctools.com